

LM49270 Boomer[®] Audio Power Amplifier Series

Filterless 2.2W Stereo Class D Audio Subsystem with OCL Headphone Amplifier, 3D Enhancement, and Headphone Sense

General Description

The LM49270 is a fully integrated audio subsystem designed for stereo multimedia applications. The LM49270 combines a 2.2W stereo Class D amplifier with a 155mW stereo headphone amplifier, volume control, headphone sense, and National's unique 3D sound enhancement into a single device. The LM49270 uses flexible I²C control interface for multiple application requirements.

The filterless stereo class D amplifiers delivers 2.2W/channel into a 4Ω load with less than 10% THD+N with a 5V supply. The headphone amplifier features National's Output Capacitor-less (OCL) architecture that eliminates the output coupling capacitors required by traditional headphone amplifiers.

The IC features a headphone sense input (HPS) that automatically detects the presence of a headphone and configures the device accordingly. The LM49270 can automatically switch from OCL headphone output to a line driver output. If the VOC pin is pulled to GND, the VOC amplifier is disabled and the VOC pin is internally set to GND. This feature allows the LM49270 to be used as a line driver in OCL mode without a GND conflict on the headphone jack sleeve. Additionally, the headphone amplifier can be configured as capacitively coupled (CC).

The LM49270 features a 32 step volume control for the headphone and stereo outputs. The device mode select and volume are controlled through an I²C compatible interface.

Output short circuit and thermal shutdown protection prevent the device from being damaged during fault conditions. Superior click and pop suppression eliminates audible transients on power-up/down and during shutdown. The LM49270 is available in a space saving 28-pin, 5x5mm LLP package.

Key Specifications

■ Stereo Class D Amplifier Efficiency:		
$V_{DD} = 3.3V$, 450mW/Ch into 8Ω		84%
$V_{DD} = 5V$, 1W/Ch into 8Ω		84%
■ Quiescent Power Supply Current, $V_{DD} = 3.3V$		
Speaker Mode		5.5mA
Headphone Mode (OCL)		4mA
■ Power Output/Channel, $V_{DD} = 5V$		
Class D Speaker amplifier:		
$R_L = 4\Omega$, THD+N = ≤ 10%		2.2W
$R_L = 8\Omega$, THD+N = ≤ 1%		1.06W
Headphone amplifier:		
$R_L = 16\Omega$, THD+N = ≤ 1%		155mW
$R_L = 32\Omega$, THD+N = ≤ 1%		90mW
■ Shutdown current		0.02μA

Features

- Stereo filterless Class D amplifier
- Selectable OCL/CC headphone amplifier
- Headphone sense ability
- National's 3D Enhancement
- RF suppression
- I²C control interface
- 32-step digital volume control
- 6 Operating Modes
- Output short circuit protection and thermal shutdown protection
- Minimum external components
- Click and Pop suppression
- Micro-power shutdown
- Independent speaker and headphone volume controls
- Available in space-saving 28 pin LLP package

Applications

- Portable DVD players
- Smart phones
- PDAs
- Laptops

Typical Application

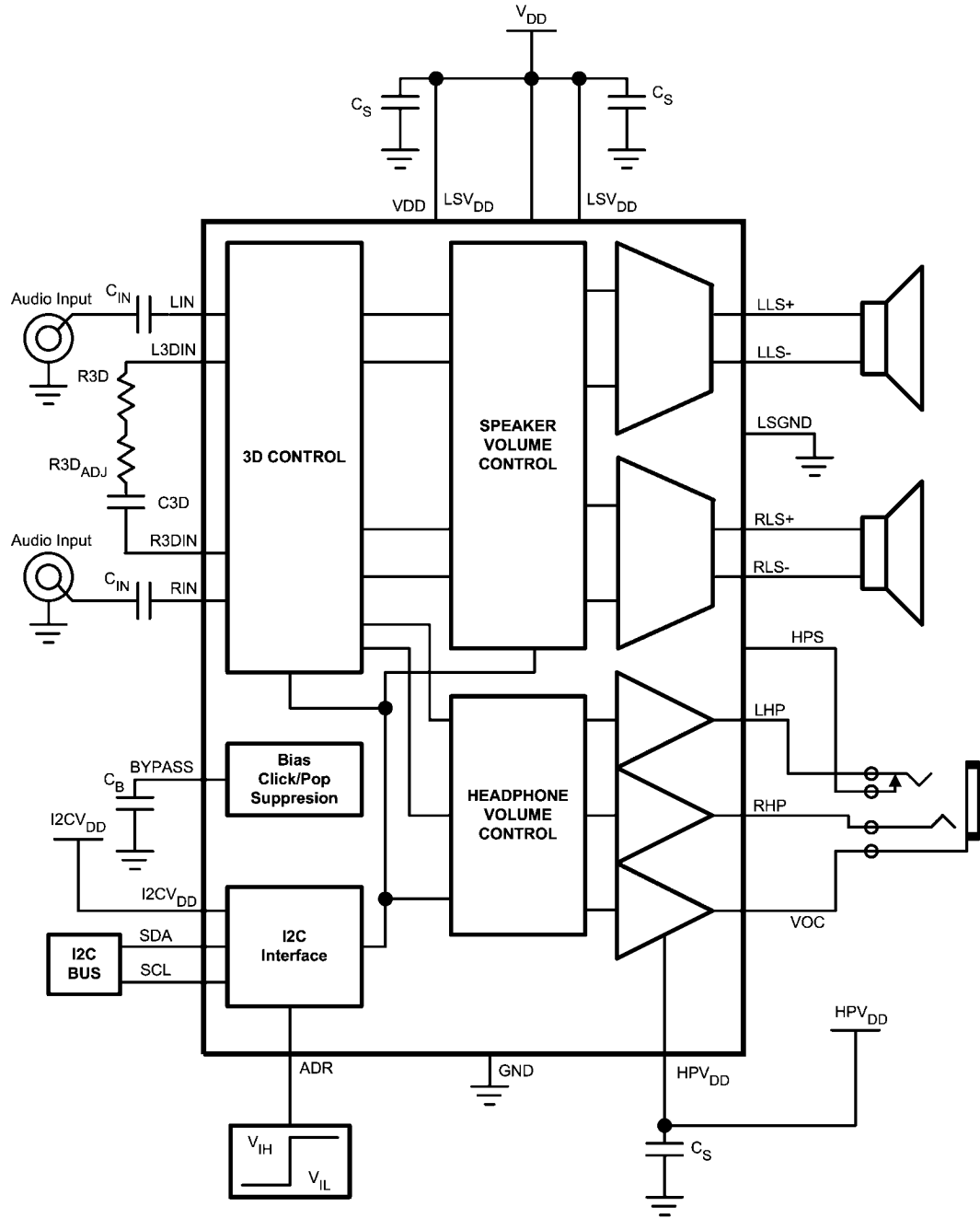

20212994

FIGURE 1. Typical Audio Amplifier Application Circuit

Connection Diagrams

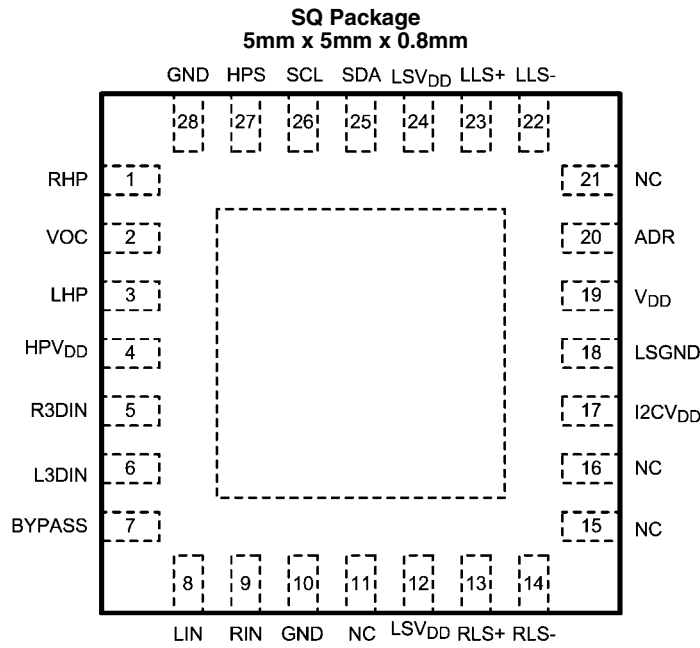

20212990

Top View
Order Number LM49270SQ
See NS Package Number NSQAQ028

SQ Markings

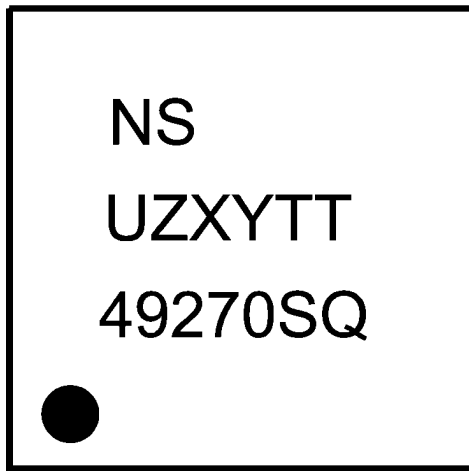

20212901

Top View
NS = National Logo
U = Fab Code
Z = Assembly Plant
XY = 2 Digit date code
TT = Die Traceability
49270SQ = LM49270SQ

TABLE 1. Pin Descriptions

PIN	NAME	DESCRIPTION
1	RHP	Right channel headphone output
2	VOC	VDD/2 buffer output
3	LHP	Left channel headphone output
4	HPV _{DD}	Headphone supply input
5	R3DIN	Right channel 3D input
6	L3DIN	Left channel 3D input
7	BYPASS	Bias bypass
8	LIN	Left channel input
9	RIN	Right channel input
10	GND	Analog ground
11	NC	No connect
12	LSV _{DD}	Speaker supply voltage input
13	RLS+	Right channel non-inverting speaker output
14	RLS-	Right channel inverting speaker output
15	NC	No connect
16	NC	No connect
17	I2CV _{DD}	I2C supply voltage input
18	LSGND	Speaker ground
19	V _{DD}	Power supply
20	ADR	Address
21	NC	No connect
22	LLS-	Left channel inverting speaker output
23	LLS+	Left channel non-inverting speaker output
24	LSV _{DD}	Speaker supply voltage input
25	SDA	Serial data input
26	SCL	Serial clock input
27	HPS	Headphone sense input
28	GND	Headphone ground

Absolute Maximum Ratings (Notes 1, 2)

If Military/Aerospace specified devices are required, please contact the National Semiconductor Sales Office/Distributors for availability and specifications.

Supply Voltage (Note 1)	6.0V
Storage Temperature	-65°C to +150°C
Input Voltage	-0.3V to $V_{DD} + 0.3V$
Power Dissipation (Note 3)	Internally Limited
ESD Susceptibility (Note 4)	2000V
ESD Susceptibility (Note 5)	200V
Junction Temperature (T_{JMAX})	150°C

Thermal Resistance

 θ_{JA}

35.1°C/W

Operating Ratings (Notes 1, 2)

Temperature Range

 $T_{MIN} \leq T_A \leq T_{MAX}$ $-40^\circ\text{C} \leq T_A \leq 85^\circ\text{C}$

Supply Voltage

 $(V_{DD}, LSV_{DD}, HPV_{DD})$ $2.4V \leq V_{DD} \leq 5.5V$ I²C Voltage (I²CV_{DD}) $2.4V \leq I^2CV_{DD} \leq 5.5V$ **Electrical Characteristics $V_{DD} = 3.3V$** (Notes 1, 2) The following specifications apply for Headphone:

$A_V = 0\text{dB}$, $R_{L(HP)} = 32\Omega$; for Loudspeakers: $A_V = 6\text{dB}$, $R_{L(SP)} = 15\mu\text{H} + 8\Omega + 15\mu\text{H}$, $f = 1\text{kHz}$, unless otherwise specified. Limits apply for $T_A = 25^\circ\text{C}$.

Symbol	Parameter	Conditions	LM49270		Units (Limits)
			Typical	Limit	
			(Note 6)	(Notes 7, 8)	
I_{DD}	Supply Current	$V_{IN} = 0$, $R_L = \text{No Load}$, Both channels active			
		Speaker ON, HP OFF	5.5	7.6	mA (max)
		Speaker OFF, CC HP ON	3	4.7	mA (max)
		Speaker OFF, OCL HP ON	4	5.75	mA (max)
I_{SD}	Shutdown Supply Current		0.02	2	μA (max)
V_{OS}	Output Offset Voltage	Headphone	10	25	mV (max)
		Speaker	10	60	mV (max)
P_{OUT}	Output Power	Speaker Mode, $f = 1\text{kHz}$			
		THD+N = 1%			
		$R_L = 4\Omega$	700		mW
		$R_L = 8\Omega$	450	400	mW (min)
		THD+N = 10%			
		$R_L = 4\Omega$	870		mW
		$R_L = 8\Omega$	560		mW
		CC Headphone Mode, $f = 1\text{kHz}$			
		THD+N = 1%			
		$R_L = 16\Omega$	60		mW
		$R_L = 32\Omega$	36	30	mW (min)
		THD+N = 10%			
$R_L = 16\Omega$	74		mW		
$R_L = 32\Omega$	55		mW		
OCL Headphone Mode, $f = 1\text{kHz}$					
THD+N = 1%					
$R_L = 16\Omega$	60		mW		
$R_L = 32\Omega$	36	30	mW (min)		
THD+N = 10%					
$R_L = 16\Omega$	73		mW		
$R_L = 32\Omega$	55		mW		

Symbol	Parameter	Conditions	LM49270		Units (Limits)
			Typical	Limit	
			(Note 6)	(Notes 7, 8)	
THD+N	Total Harmonic Distortion + Noise	Speaker Mode, $f = 1\text{kHz}$ $P_{\text{OUT}} = 100\text{mW}$, $R_L = 8\Omega$	0.02		%
		CC Headphone Mode, $f = 1\text{kHz}$ $P_{\text{OUT}} = 12\text{mW}$, $R_L = 32\Omega$	0.015		%
		OCL Headphone Mode, $f = 1\text{kHz}$ $P_{\text{OUT}} = 12\text{mW}$, $R_L = 32\Omega$	0.02		%
e_N	Noise	Speaker Mode, A-Wtg, Input Referred	47		μV
		CC Headphone Mode, A-Wtg, Input Referred	10		μV
		OCL Headphone Mode, A-Wtg, Input Referred	11		μV
η	Efficiency	Speaker Mode $R_L = 8\Omega$	84		%
Xtalk	Crosstalk	Speaker Mode, $f = 1\text{kHz}$, $V_{\text{IN}} = 1\text{Vp-p}$	71		dB
		CC Headphone Mode, $f = 1\text{kHz}$, $V_{\text{IN}} = 1\text{Vp-p}$	70		dB
		OCL Headphone Mode, $f = 1\text{kHz}$, $V_{\text{IN}} = 1\text{Vp-p}$	55		dB
T_{ON}	Turn-on Time		30		ms
T_{OFF}	Turn-off Time		64		ms
Z_{IN}	Input Impedance	Maximum Gain	23.5		$\text{k}\Omega$
		Minimum Gain	210		$\text{k}\Omega$
A_V	Gain	Maximum Gain, Speaker Mode	30		dB
		Minimum Gain, Speaker Mode	-47		dB
		Maximum Gain, Headphone Mode	18		dB
		Minimum Gain, Headphone Mode	-59		dB
PSRR	Power Supply Rejection Ratio	Speaker Mode, $V_{\text{RIPPLE}} = 200\text{mVp-p}$ Sine $f = 217\text{Hz}$ $f = 1\text{kHz}$	68		dB
		Headphone Mode, $V_{\text{RIPPLE}} = 200\text{mVp-p}$ Sine, CC Mode $f = 217\text{Hz}$ $f = 1\text{kHz}$	73		dB
		Headphone Mode, $V_{\text{RIPPLE}} = 200\text{mVp-p}$ Sine, OCL Mode $f = 217\text{Hz}$ $f = 1\text{kHz}$	75		dB
			68		dB
			73		dB
			79		dB
$\text{HPS}_{(\text{Th})}$	Headphone Sense Threshold	Detect Headphone		2.9	V (min)
		Detect no Headphone		1.8	V (max)

Electrical Characteristics $V_{DD} = 5.0V$ (Notes 2, 1) The following specifications apply for Headphone*

$A_V = 0dB$, $R_{L(HP)} = 32\Omega$; for Loudspeakers: $A_V = 6dB$, $R_{L(SP)} = 15\mu H + 8\Omega + 15\mu H$, $f = 1kHz$ unless otherwise specified. Limits apply for $T_A = 25^\circ C$.

Symbol	Parameter	Conditions	LM49270		Units (Limits)
			Typical	Limit	
			(Note 6)	(Notes 7, 8)	
I_{DD}	Supply Current	$V_{IN} = 0$, $R_L =$ No Load, Both channels active			
		Speaker ON, HP OFF	8.5	12.4	mA (max)
		Speaker OFF, CC HP ON	3.6	5.5	mA (max)
		Speaker OFF, OCL HP ON	4.7	6.5	mA (max)
I_{SD}	Shutdown Supply Current		0.15	2	μA (max)
V_{OS}	Output Offset Voltage	Headphone	10	25	mV (max)
		Speaker	10	60	mV (max)
P_{OUT}	Output Power	Speaker Mode, $f = 1kHz$,			
		THD+N = 1%			
		$R_L = 4\Omega$	1.75		W
		$R_L = 8\Omega$	1.06		W
		THD+N = 10 %			
		$R_L = 4\Omega$	2.2		W
		$R_L = 8\Omega$	1.35		W
		CC Headphone Mode, $f = 1kHz$,			
		THD+N = 1%			
		$R_L = 16\Omega$	155		mW
		$R_L = 32\Omega$	90		mW
		THD+N = 10%			
$R_L = 16\Omega$	177		mW		
$R_L = 32\Omega$	140		mW		
OCL Headphone Mode, $f = 1kHz$,					
THD+N = 1%					
$R_L = 16\Omega$	155		mW		
$R_L = 32\Omega$	90		mW		
THD+N = 10%					
$R_L = 16\Omega$	175		mW		
$R_L = 32\Omega$	140		mW		
THD+N	Total Harmonic Distortion + Noise	Speaker Mode, $f = 1kHz$ $P_{OUT} = 100mW$, $R_L = 8\Omega$	0.03		%
		CC Headphone Mode, $f = 1kHz$ $P_{OUT} = 12mW$, $R_L = 32\Omega$	0.02		%
		OCL Headphone Mode, $f = 1kHz$ $P_{OUT} = 12mW$, $R_L = 32\Omega$	0.03		%
e_N	Noise	Speaker Mode, A-Wtg, Input Referred	47		μV
		CC Headphone Mode, A-Wtg, Input Referred	10		μV
		OCL Headphone Mode, A-Wtg, Input Referred	11		μV
η	Efficiency	Speaker Mode $R_L = 8\Omega$	84		%

Symbol	Parameter	Conditions	LM49270		Units (Limits)
			Typical	Limit	
			(Note 6)	(Notes 7, 8)	
Xtalk	Crosstalk	Speaker Mode, f = 1kHz, V _{IN} = 1Vp-p	-85		dB
		CC Headphone Mode, f = 1kHz, V _{IN} = 1Vp-p	-70		dB
		OCL Headphone Mode, f = 1kHz, V _{IN} = 1Vp-p	-58		dB
T _{ON}	Turn-on Time		43		ms
T _{OFF}	Turn-off Time		100		ms
Z _{IN}	Input Impedance	Maximum Gain	23.5		kΩ
		Minimum Gain	210		kΩ
A _V	Gain	Maximum Gain, Speaker Mode	30		dB
		Minimum Gain, Speaker Mode	-47		dB
		Maximum Gain, Headphone Mode	18		dB
		Minimum Gain, Headphone Mode	-59		dB
PSRR	Power Supply Rejection Ratio	Speaker Mode, V _{RIPPLE} = 200mVp-p Sine f = 217Hz f = 1kHz	61 61		dB dB
		Headphone Mode, V _{RIPPLE} = 200mVp-p Sine, CC Mode f = 217Hz f = 1kHz	75 74		dB min
		Headphone Mode, V _{RIPPLE} = 200mVp-p Sine, OCL Mode f = 217Hz f = 1kHz	78 75		dB dB
HPS _(Th)	Headphone Sense Threshold	Detect Headphone		4.4	V (min)
		Detect no Headphone		3	V (max)

Note 1: All voltages are measured with respect to the ground pin, unless otherwise specified.

Note 2: *Absolute Maximum Ratings* indicate limits beyond which damage to the device may occur. *Operating Ratings* indicate conditions for which the device is functional, but do not guarantee specific performance limits. *Electrical Characteristics* state DC and AC electrical specifications under particular test conditions which guarantee specific performance limits. This assumes that the device is within the Operating Ratings. Specifications are not guaranteed for parameters where no limit is given, however, the typical value is a good indication of device performance.

Note 3: The maximum power dissipation must be derated at elevated temperatures and is dictated by T_{JMAX}, θ_{JA}, and the ambient temperature, T_A. The maximum allowable power dissipation is P_{DMAX} = (T_{JMAX} - T_A) / θ_{JA} or the number given in Absolute Maximum Ratings, whichever is lower. For the LM49270 see power derating currents for more information.

Note 4: Human body model, 100pF discharged through a 1.5kΩ resistor.

Note 5: Machine Model, 220pF–240pF discharged through all pins.

Note 6: Typical values are measured at 25°C and represent the parametric norm.

Note 7: Limits are guaranteed to National's AOQL (Average Outgoing Quality Level).

Note 8: Datasheet min/max specification limits are guaranteed by design, test, or statistical analysis.

Typical Performance Characteristics

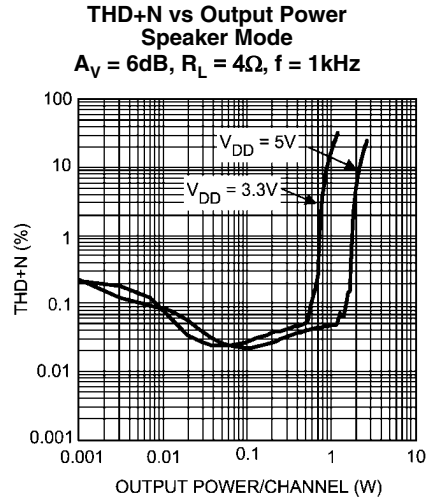

20212902

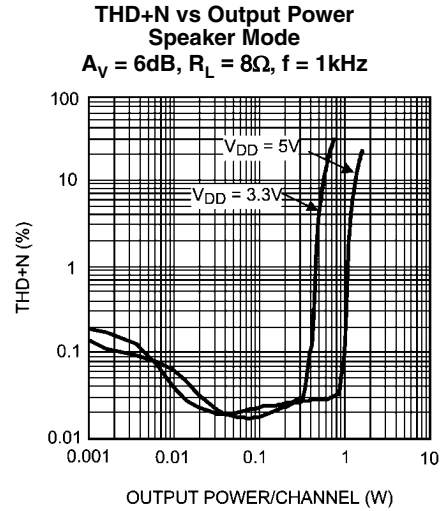

20212903

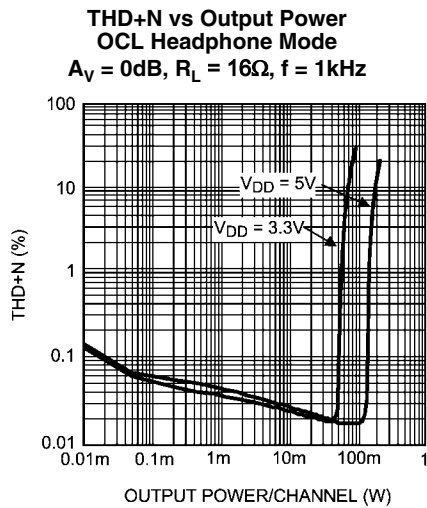

20212908

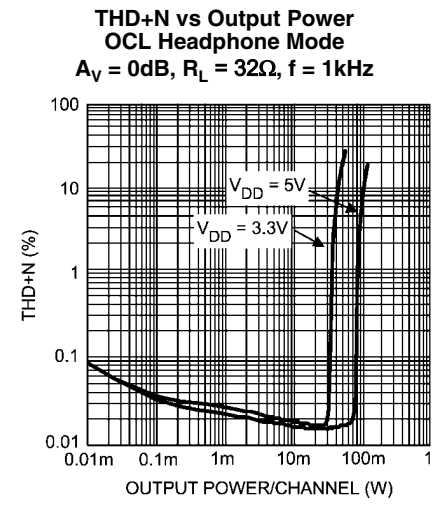

20212909

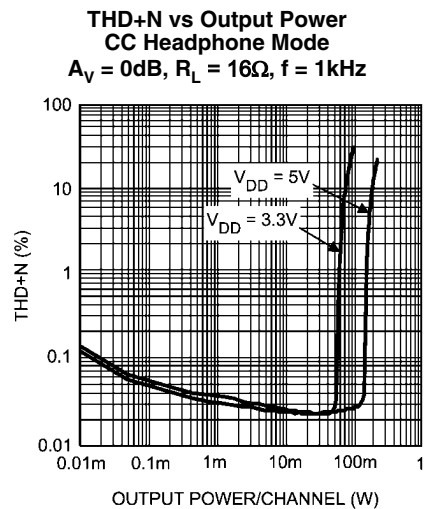

20212914

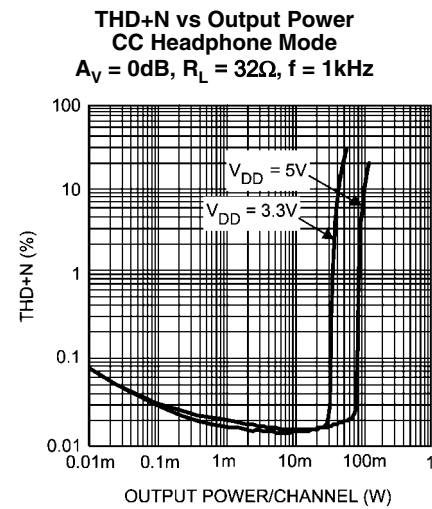

20212915

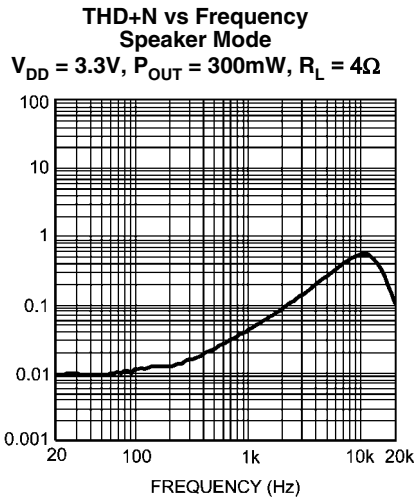

20212904

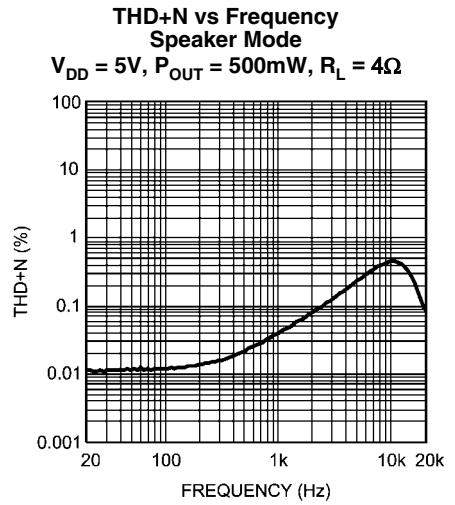

20212905

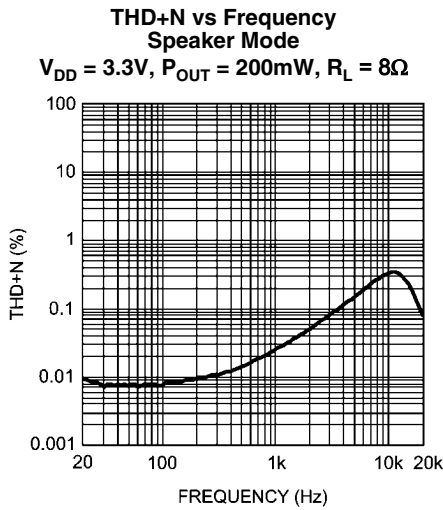

20212906

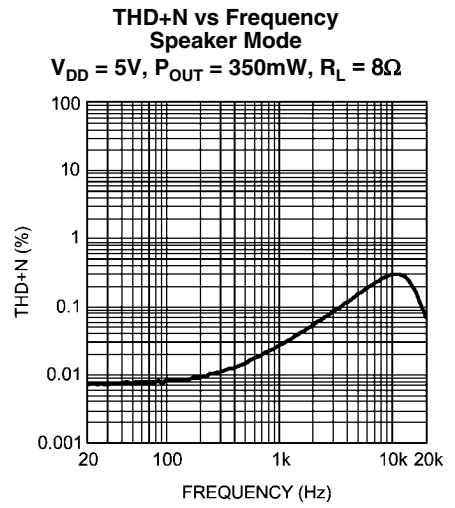

20212907

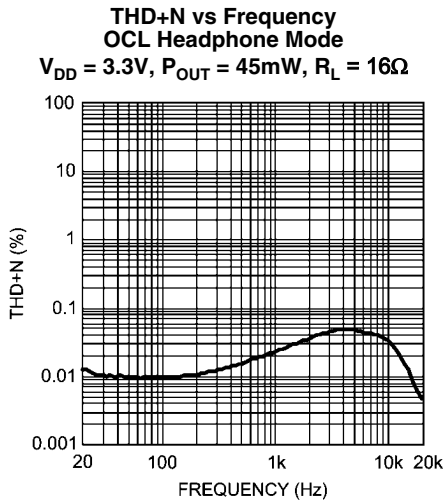

20212910

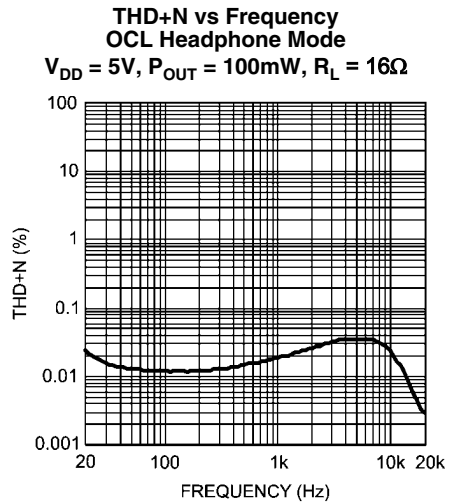

20212911

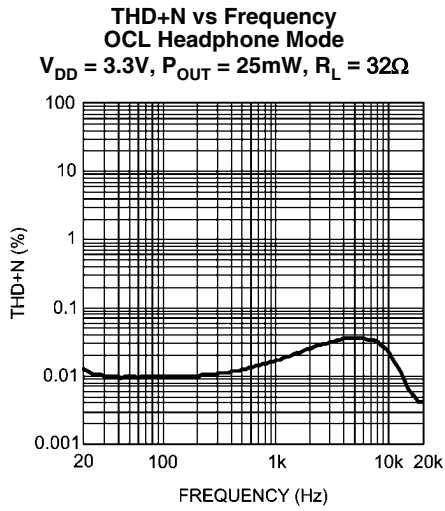

20212912

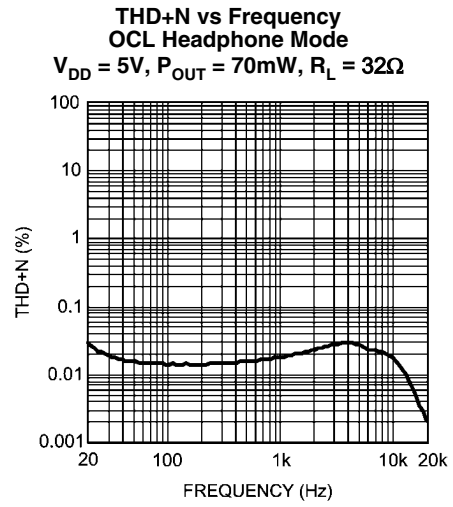

20212913

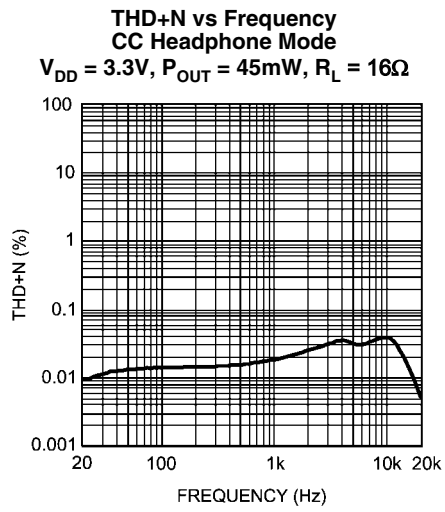

20212916

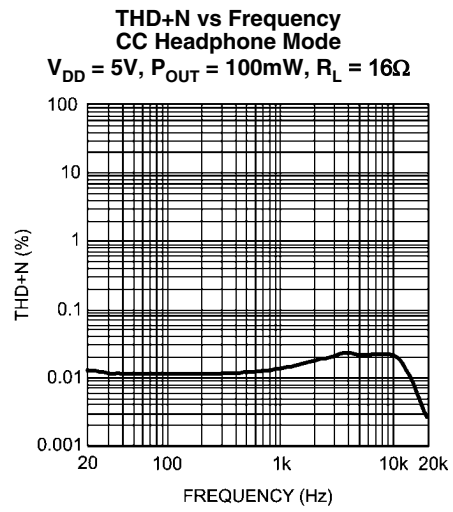

20212917

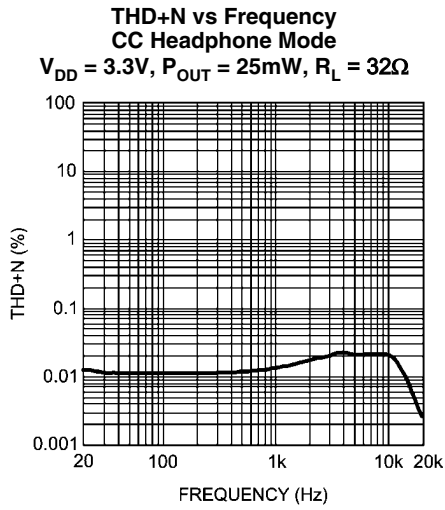

20212918

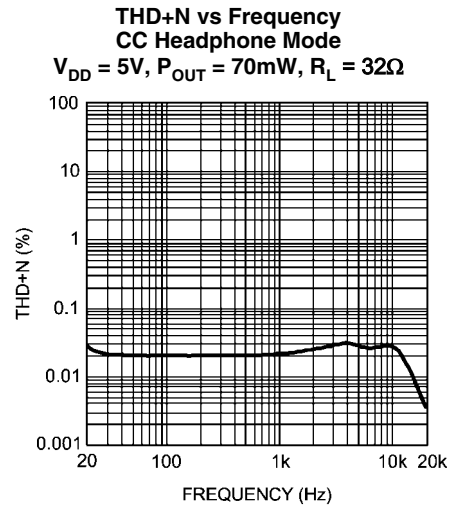

20212919

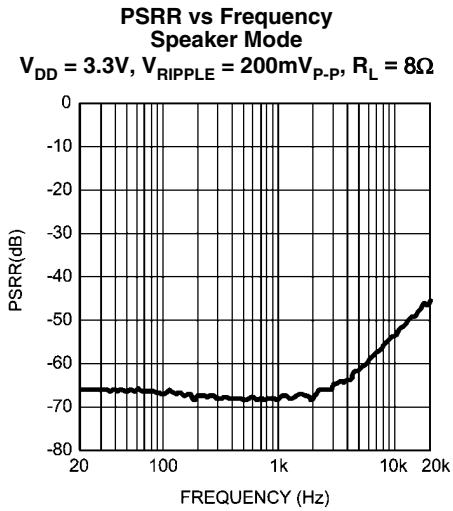

202129a2

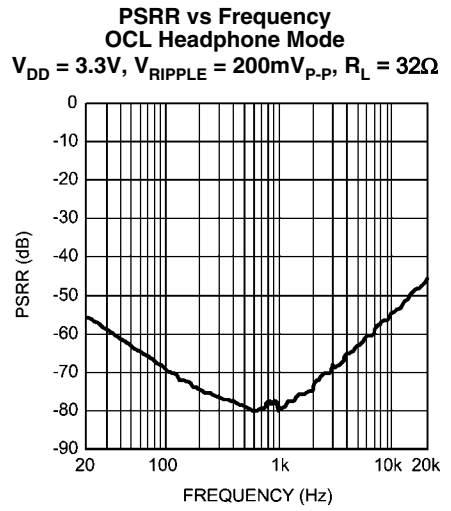

202129a3

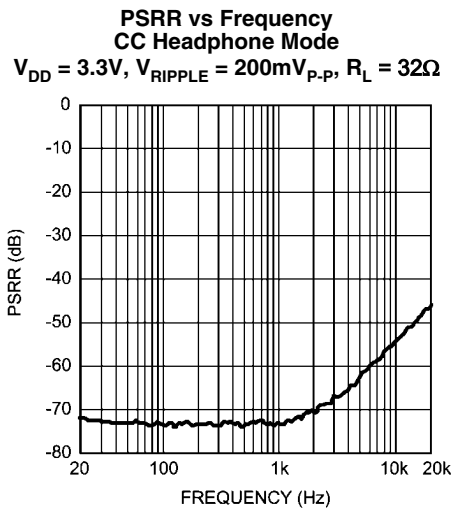

202129a4

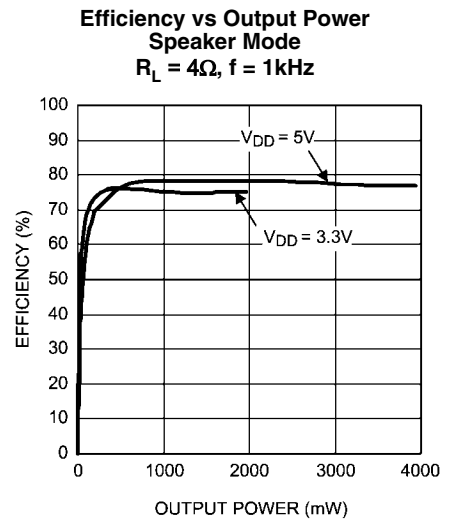

20212967

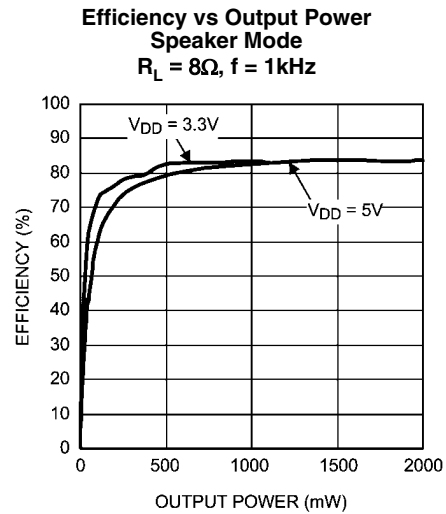

20212968

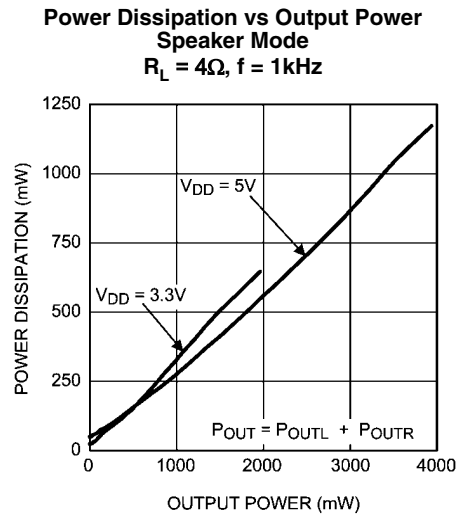

20212969

**Power Dissipation vs Output Power
Speaker Mode
 $R_L = 8\Omega, f = 1\text{kHz}$**

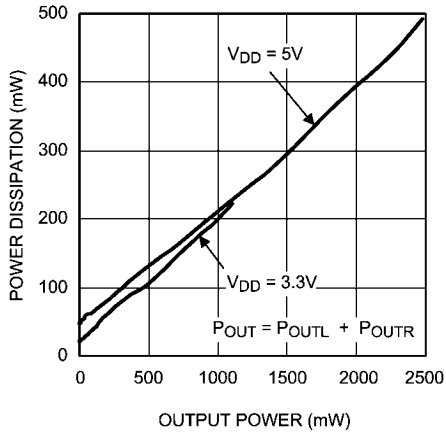

20212970

**Power Dissipation vs Output Power
OCL Headphone Mode
 $R_L = 16\Omega, f = 1\text{kHz}$**

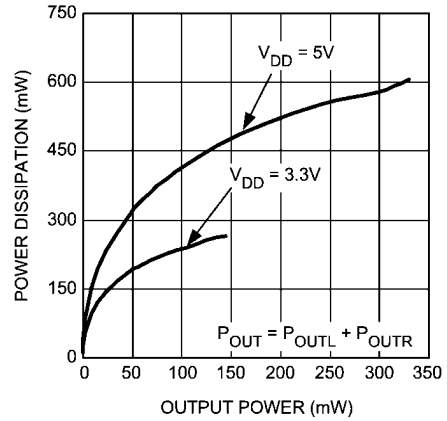

20212988

**Power Dissipation vs Output Power
OCL Headphone Mode
 $R_L = 32\Omega, f = 1\text{kHz}$**

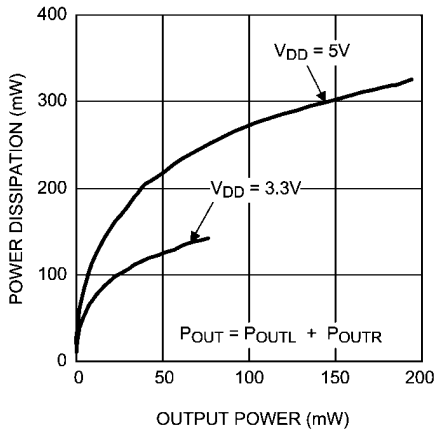

20212977

**Power Dissipation vs Output Power
CC Headphone Mode
 $R_L = 16\Omega, f = 1\text{kHz}$**

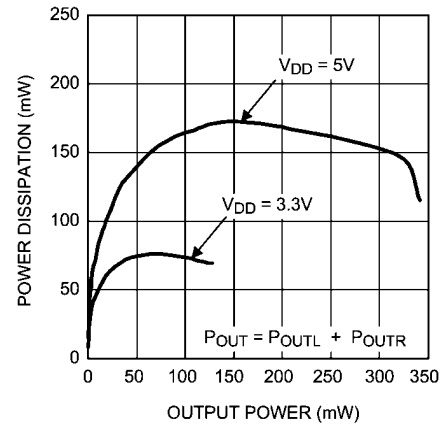

20212982

**Power Dissipation vs Output Power
CC Headphone Mode
 $R_L = 32\Omega, f = 1\text{kHz}$**

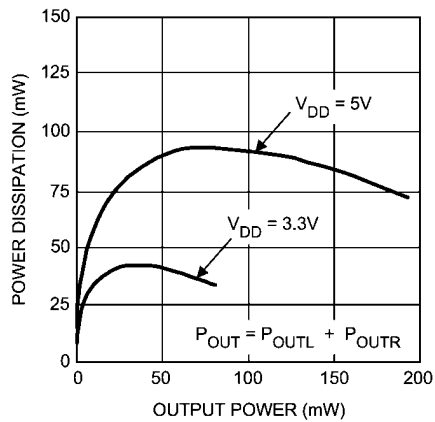

20212983

**Output Power vs Supply Voltage
Speaker Mode
 $R_L = 4\Omega, f = 1\text{kHz}$**

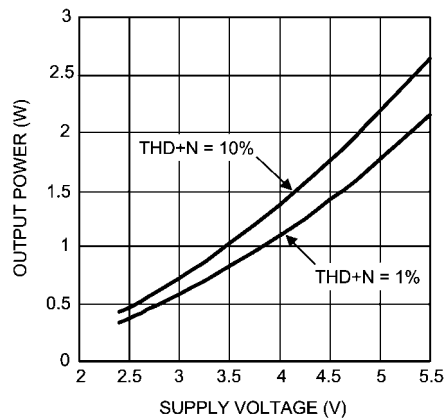

20212971

**Output Power vs Supply Voltage
Speaker Mode
 $R_L = 8\Omega$, $f = 1\text{kHz}$**

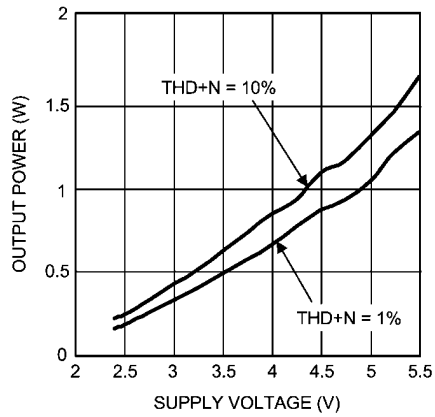

20212972

**Output Power vs Supply Voltage
OCL Headphone Mode
 $R_L = 16\Omega$, $f = 1\text{kHz}$**

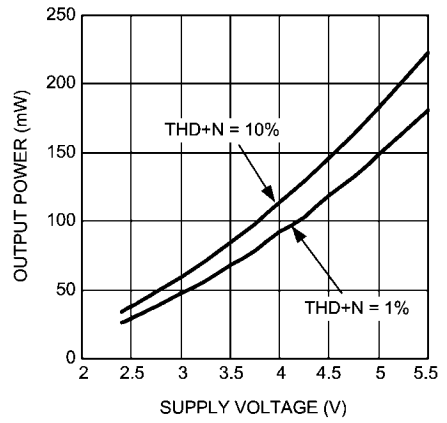

20212995

**Output Power vs Supply Voltage
OCL Headphone Mode
 $R_L = 32\Omega$, $f = 1\text{kHz}$**

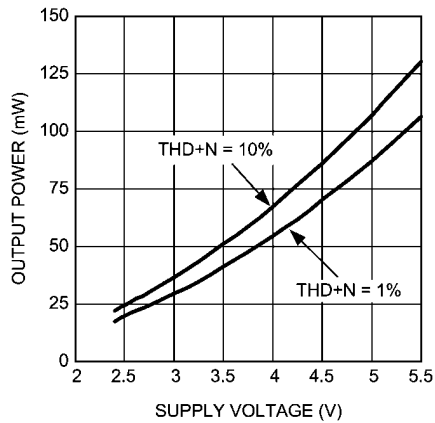

20212996

**Output Power vs Supply Voltage
CC Headphone Mode
 $R_L = 16\Omega$, $f = 1\text{kHz}$**

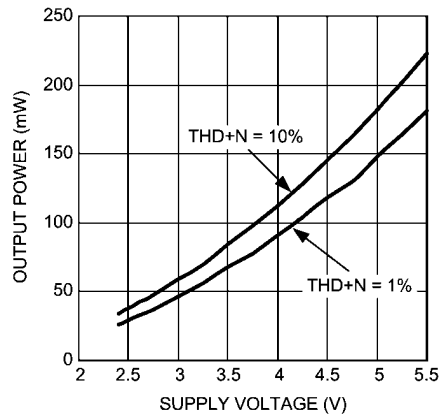

20212997

**Output Power vs Supply Voltage
CC Headphone Mode
 $R_L = 32\Omega$, $f = 1\text{kHz}$**

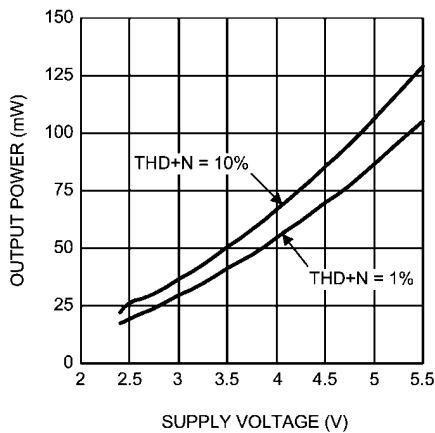

20212985

**Crosstalk vs Frequency
Speaker Mode
 $V_{DD} = 3.3\text{V}$, $V_{RIPPLE} = 1\text{V}_{P-P}$, $R_L = 8\Omega$**

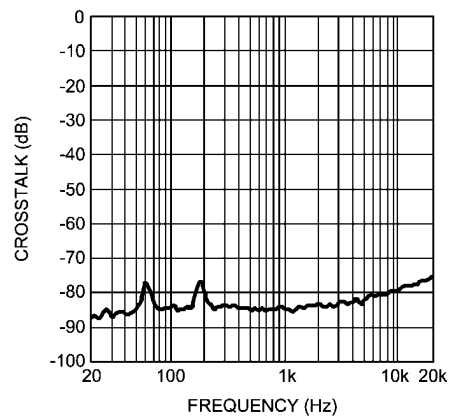

202129a0

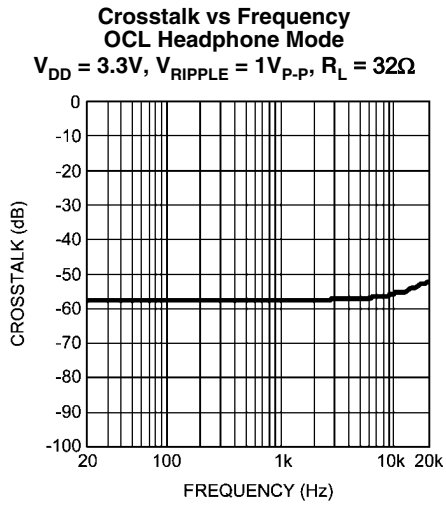

20212989

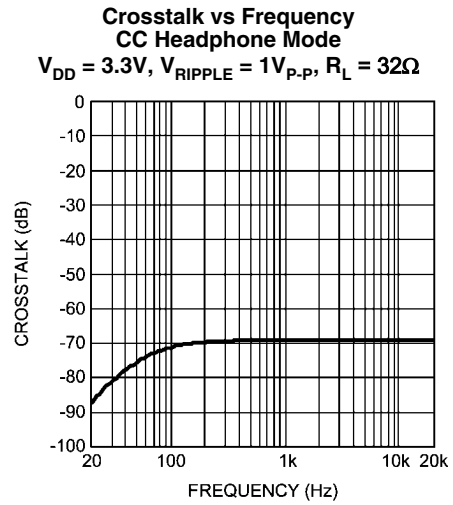

202129a1

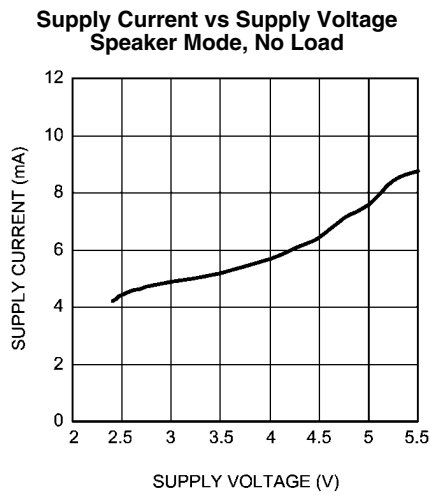

20212975

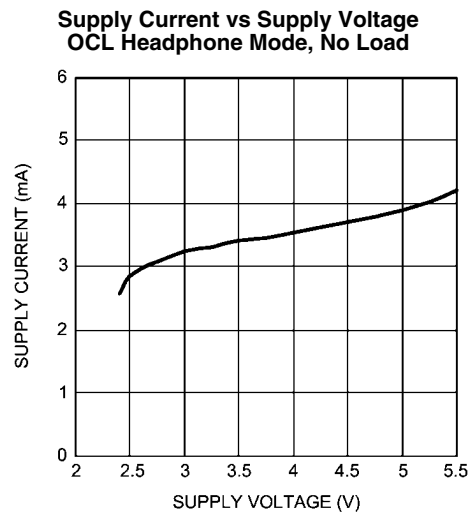

20212981

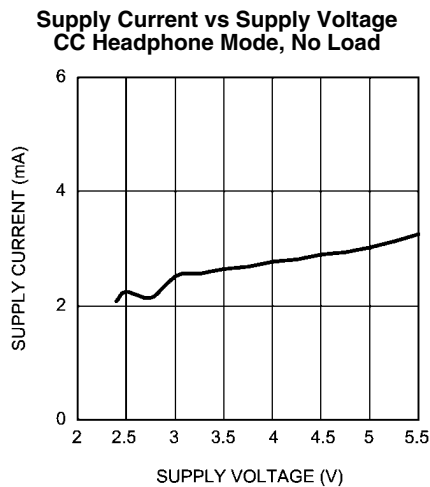

20212988

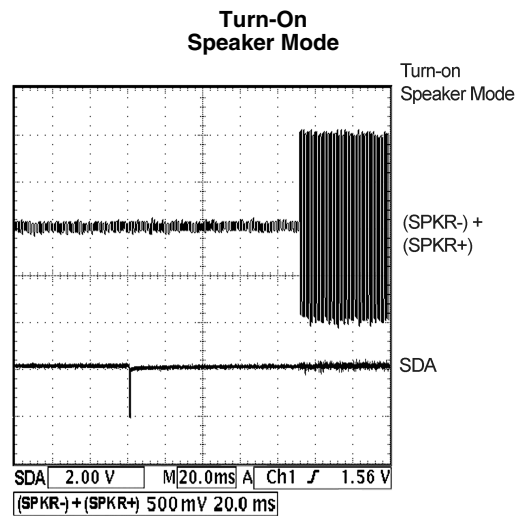

20212927

Turn-Off Speaker Mode

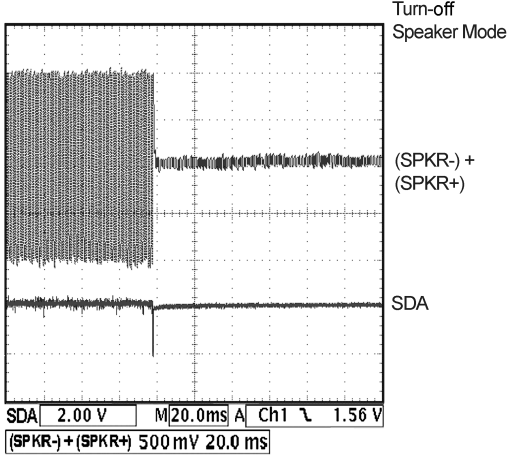

20212928

Turn-On OCL Headphone Mode

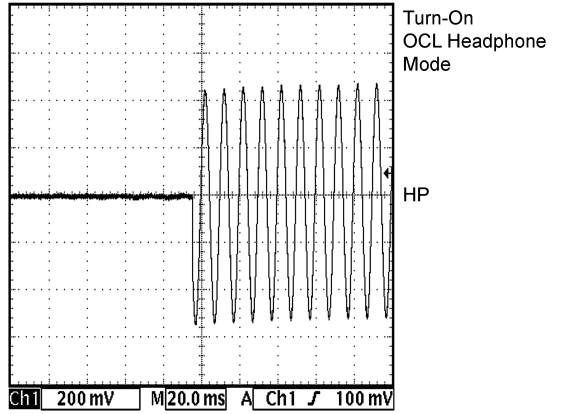

20212929

Turn-Off OCL Headphone Mode

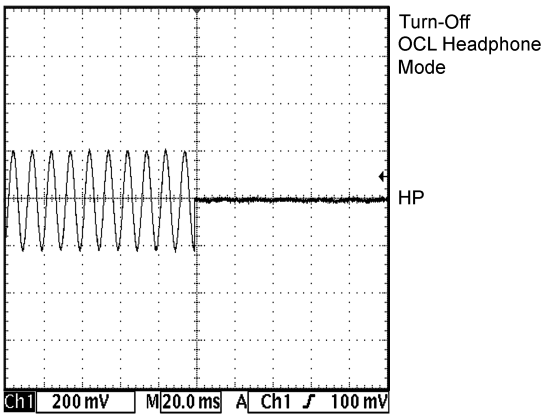

20212930

Turn-On CC Headphone Mode

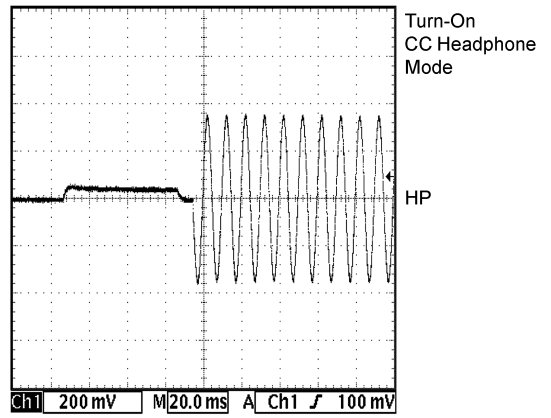

20212931

Turn-Off CC Headphone Mode

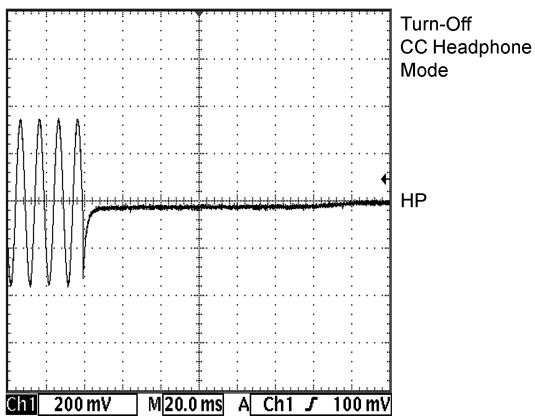

20212932

Application Information

I²C COMPATIBLE INTERFACE

The LM49270 is controlled through an I²C compatible serial interface that consists of a serial data line (SDA) and a serial clock (SCL). The clock line is uni-directional. The data line is bi-directional (open-collector), although the LM49270 does not write to the I²C bus. The LM49270 and the master can communicate at clock rates up to 400kHz. Figure 3 shows the I²C interface timing diagram. The LM49270 is a transmit/receive slave-only device, reliant upon the master to generate a clock signal.

The master device communicates to the LM49270 by transmitting the proper device address followed by a command

word. Each transmission sequence is framed by a START condition and a STOP condition. Each word (register address + register content) transmitted over the bus is 8 bits long and is always followed by an acknowledge pulse.

To avoid an address conflict with another device on the I²C bus, the LM49270 address is determined by the ADR pin, the state of ADR determines address bit A1 (Table 2). When ADR = 0, the address is 1111 1000. When ADR = 1 the device address is 1111 1010.

TABLE 2. Device Address

ADR	A7	A6	A5	A4	A3	A2	A1	A0
X	1	1	1	1	1	0	X	0
0	1	1	1	1	1	0	0	0
1	1	1	1	1	1	0	1	0

TABLE 3. I²C Control Registers

REG	Register Name	D7	D6	D5	D4	D3	D2	D1	D0
0	Shutdown Control	0	0	—	—	HP3DSEL	LS3DSEL	OCL/CC	PWR_ON
1	Headphone Gain Control	0	1	—	HP4	HP3	HP2	HP1	HP0
2	Speaker Gain Control	1	0	—	LS4	LS3	LS2	LS1	LS0

Note: OCL/CC = 1 selects OCL mode; OCL/CC = 0 selects cap coupled mode

PWR_ON = 0 puts part in shutdown

BUS FORMAT

The I²C bus format is shown in Figure 2. The “start” signal is generated by lowering the data signal while the clock is high. The start signal alerts all devices on the bus that a device address is being written to the bus.

The 8-bit device address is written to the bus next, most significant bit first. The data is latched in on the rising edge of the clock. Each address bit must be stable while the clock is high.

After the last address bit is sent, the master device releases the data line, during which time, an acknowledge clock pulse is generated. If the LM49270 receives the address correctly, then the LM49270 pulls the data line low, generating an acknowledge bit (ACK).

Once the master device has registered the ACK bit, the 8-bit register address/data word is sent. Each data bit should be stable while the clock level is high. After the 8-bit word is sent, the LM49270 sends another ACK bit. Following the acknowledgement of the data word, the master device issues a “stop” bit, allowing SDA to go high while the clock signal is high.

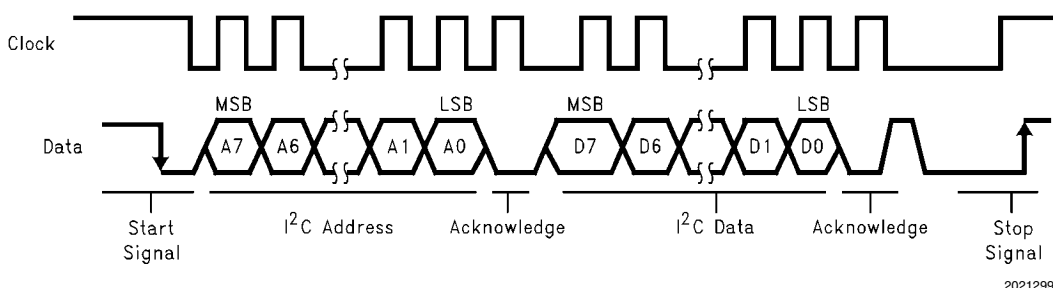

20212991

FIGURE 2. I²C Bus Format

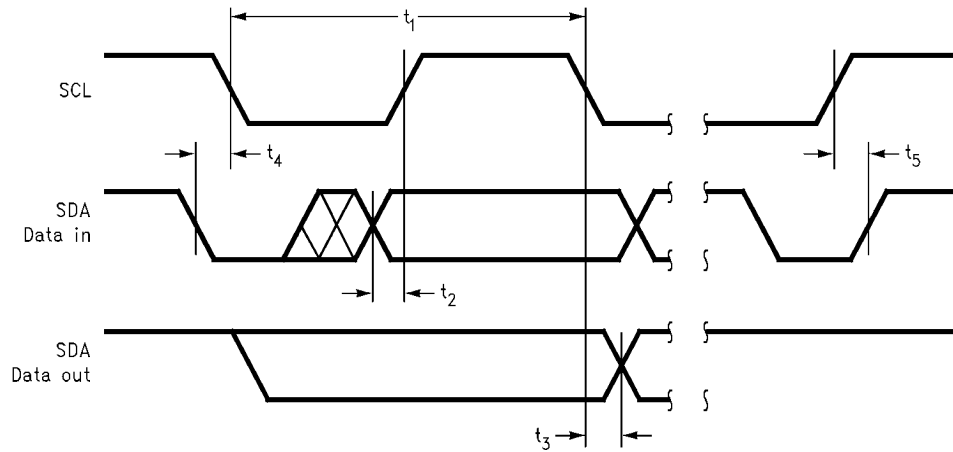

20212992

FIGURE 3. I²C Timing Diagram

GENERAL AMPLIFIER FUNCTION

Class D Amplifier

The LM49270 features a high-efficiency, filterless, Class D stereo amplifier. The LM49270 Class D amplifiers feature a filterless modulation scheme known as Class BD. The differential outputs of each channel switch at 300kHz from V_{DD} to GND. When there is no input signal applied, the two outputs (LLS+ and LLS-) switch in phase with a 50% duty cycle. Because the outputs of the LM49270 are differential, there is no net voltage across the speaker, thus no load current during the idle state conserving power.

When an input signal is applied, the duty cycle (pulse width) of each output changes. For increasing output voltages, the duty cycle of LLS+ increases, while the duty cycle of LLS- decreases. For decreasing output voltages, the converse occurs. The duty cycle of LLS- increases while the duty cycle of LLS+ decreases. The difference between the two pulse widths yields the differential output voltage.

Headphone Amplifier

The LM49270 headphone amplifier features two different operating modes, output capacitor-less (OCL) and capacitor coupled (CC). The OCL architecture eliminates the bulky, expensive output coupling capacitors required by traditional headphone amplifiers. The LM49270 headphone section uses three amplifiers. Two amplifiers drive the headphones while the third (VOC) is set to the internally generated bias voltage (typically $V_{DD}/2$). The third amplifier is connected to the return terminal (sleeve) of the headphone jack. In this configuration, the signal side of the headphones are biased to $V_{DD}/2$, the return is biased to $V_{DD}/2$, thus there is no net DC voltage across the headphone eliminating the need for an output coupling capacitor. Removing the output coupling capacitors from the headphone signal path reduces component count, reducing system cost and board space consumption, as well as improving low frequency performance and sound quality. The voltage on the return sleeve is not an issue when driving headphones. However, if the headphone output is used as a line out, the $V_{DD}/2$ can conflict with the GND potential that a line-in would expect on the return sleeve. When the return of the headphone jack is connected to GND, the LM49270 detects an output short circuit condition and the VOC amplifier is disabled preventing damage to the LM49270 and allowing the headphone return to be biased at GND.

Capacitor Coupled Headphone Mode

In capacitor coupled (CC) mode, the VOC pin is disabled, and the headphone outputs are coupled to the jack through series capacitors, allowing the headphone return to be connected to GND (Figure 4). In CC mode, the LM49270 requires output coupling capacitors to block the DC component of the amplifier output, preventing DC current from flowing to the load. The output capacitor and speaker impedance form a high pass filter with a -3dB roll-off determined by:

$$f_{-3dB} = 1 / 2\pi R_L C_{OUT}$$

Where R_L is the headphone impedance, and C_{OUT} is the output coupling capacitor. Choose C_{OUT} such that f_{-3dB} is well below the lowest frequency of interest. Setting f_{-3dB} too high results in poor low frequency performance. Select capacitor dielectric types with low ESR to minimize signal loss due to capacitor series resistance and maximize power transfer to the load.

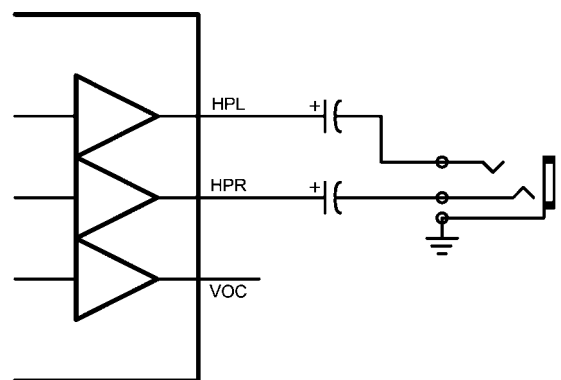

20212993

FIGURE 4. Capacitor Coupled Headphone Mode

Headphone Sense

The LM49270 features a headphone sense input (HPS) that monitors the headphone jack and configures the device depending on the presence of a headphone. When the HPS pin is low, indicating that a headphone is not present, the LM49270 speaker amplifiers are active and the headphone

amplifiers are disabled. When the HPS pin is high, indicating that a headphone is present, the headphone amplifiers are active while the speaker amplifiers are disabled.

POWER DISSIPATION AND EFFICIENCY

The major benefit of Class D amplifier is increased efficiency versus Class AB. The efficiency of the LM49270 speaker amplifiers is attributed to the output transistors' region of operation. The Class D output stage acts as current steering switches, consuming negligible amounts of power compared to their Class AB counterparts. Most of the power loss associated with the output stage is due to the IR loss of the MOSFET on-resistance ($R_{DS(ON)}$), along with the switching losses due to gate charge.

The maximum power dissipation per headphone channel in Capacitor Coupled mode is given by:

$$P_{DMAX(CC)} = V_{DD}^2/2\pi^2R_L$$

In OCL mode, the maximum power dissipation increases due to the use of a third amplifier as a buffer. The power dissipation is given by:

$$P_{DMAX(OCL)} = V_{DD}^2/\pi^2R_L$$

SHUTDOWN FUNCTION

The LM49270 features a shutdown mode configured through the I²C interface. Bit D0 (PWR_ON) in the Shutdown Control register shuts down/turns on the entire device. Set PWR_ON = 1 to enable the LM49270, set PWR_ON = 0 to disable the device.

AUDIO AMPLIFIER GAIN SETTING

Each channel of the LM49270 features a 32 step volume control. The loudspeaker volume has a range of -47dB to 30dB and the headphone has a range of -59dB to 18dB (see Table 4).

TABLE 4. Volume Control

Volume Step	LS4/HP4	LS3/HP3	LS2/HP2	LS1/HP1	LS0/HP0	LS Gain (dB)	HP Gain (dB)
1	0	0	0	0	0	-47	-59
2	0	0	0	0	1	-36	-48
3	0	0	0	1	0	-28.5	-46.5
4	0	0	0	1	1	-22.5	-34.5
5	0	0	1	0	0	-18	-30
6	0	0	1	0	1	-15	-27
7	0	0	1	1	0	-12	-24
8	0	0	1	1	1	-9	-21
9	0	1	0	0	0	-6	-18
10	0	1	0	0	1	-3	-15
11	0	1	0	1	0	-1.5	-13.5
12	0	1	0	1	1	0	-12
13	0	1	1	0	0	1.5	-10.5
14	0	1	1	0	1	3	-9
15	0	1	1	1	0	4.5	-7.5
16	0	1	1	1	1	6	-6
17	1	0	0	0	0	7.5	-4.5
18	1	0	0	0	1	9	-3
19	1	0	0	1	0	10.5	-1.5
20	1	0	0	1	1	12	0
21	1	0	1	0	0	13.5	1.5
22	1	0	1	0	1	15	3
23	1	0	1	1	0	16.5	4.5
24	1	0	1	1	1	18	6
25	1	1	0	0	0	19.5	7.5
26	1	1	0	0	1	21	9
27	1	1	0	1	0	22.5	10.5
28	1	1	0	1	1	24	12
29	1	1	1	0	0	25.5	13.5
30	1	1	1	0	1	27	15
31	1	1	1	1	0	28.5	16.5
32	1	1	1	1	1	30	18

NATIONAL 3D ENHANCEMENT

The LM49270 features National's 3D sound enhancement. 3D sound improves the apparent stereo channel separation whenever the left and right speakers are located close to each other, widening the perceived sound stage in devices with a small form factor that prohibits proper speaker placement.

An external RC network, shown in Figure 1, enables the 3D effect. R3D sets the level of the 3D effect; decreasing the value of R3D will increase the 3D effect. The 3D network acts like a high pass filter C3D sets the frequency response; increasing the value of C3D will decrease the low cutoff frequency at which the 3D effect starts to occur, as shown by this equation:

$$f_{3D(-3dB)} = 1/2\pi(R3D)(C3D) \quad (1)$$

Enabling the 3D effect increases the gain by a multiplication factor of $(1 + 20k\Omega/R3D)$. Setting R3D to $20k\Omega$ results in a 6dB increase (doubling) of the gain, increasing the 3D effect. The level of 3D effect is also dependent on other factors such as speaker placement and the distance from the speakers to the listener. The values of R3D and C3D should be chosen for each application individually, taking into account the physical factors noted before.

POWER SUPPLIES

The LM49270 uses different supplies for each portion of the device, allowing for the optimum combination of headroom, power dissipation and noise immunity. The speaker amplifier gain stage is powered from V_{DD} , while the output stage is powered from LSV_{DD} . The headphone amplifiers, input amplifiers and volume control stages are powered from HPV_{DD} . The separate power supplies allow the speakers to operate from a higher voltage for maximum headroom, while the headphones operate from a lower voltage, improving power dissipation. HPV_{DD} may be driven by a linear regulator to further improve performance in noisy environments. The I²C portion if powered from I^2CV_{DD} , allowing the I²C portion of the LM49270 to interface with lower voltage digital controllers.

PROPER SELECTION OF EXTERNAL COMPONENTS

Audio Amplifier Power Supply Bypassing/Filtering

Proper power supply bypassing is critical for low noise performance and high PSRR. Place the supply bypass capacitor

as close to the device as possible. Typical applications employ a voltage regulator with $10\mu F$ and $0.1\mu F$ bypass capacitors that increase supply stability. These capacitors do not eliminate the need for bypassing of the LM49270 supply pins. A $1\mu F$ capacitor is recommended.

Bypass Capacitor Selection

The LM49270 generates a $V_{DD}/2$ common-mode bias voltage internally. The BYPASS capacitor, C_B , improves PSRR and THD+N by reducing noise at the BYPASS node. Use a $1\mu F$ capacitor, placed as close to the device as possible for C_B .

Audio Amplifier Input Capacitor Selection

Input capacitors, C_{IN} , in conjunction with the input impedance of the LM49270 forms a high pass filter that removes the DC bias from an incoming signal. The AC-coupling capacitor allows the amplifier to bias the signal to an optimal DC level. Assuming zero source impedance, the -3dB point of the high pass filter is given by:

$$f_{(-3dB)} = 1/2\pi R_{IN} C_{IN} \quad (2)$$

Choose C_{IN} such that f_{-3dB} is well below that lowest frequency of interest. Setting f_{-3dB} too high affects the low-frequency responses of the amplifier. Use capacitors with low voltage coefficient dielectrics, such as tantalum or aluminum electrolytic. Capacitors with high-voltage coefficients, such as ceramics, may result in increased distortion at low frequencies. Other factors to consider when designing the input filter include the constraints of the overall system. Although high fidelity audio requires a flat frequency response between 20Hz and 20kHz, portable devices such as cell phones may only concentrate on the frequency range of the frequency range of the spoken human voice (typically 300Hz to 4kHz). In addition, the physical size of the speakers used in such portable devices limits the low frequency response; in this case, frequencies below 150Hz may be filtered out.

Revision Table

Rev	Date	Description
1.0	12/19/06	Initial release.

Physical Dimensions inches (millimeters) unless otherwise noted

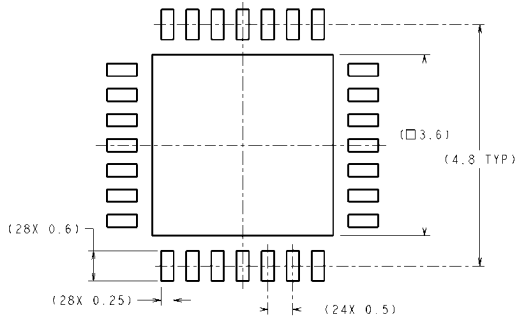

RECOMMENDED LAND PATTERN

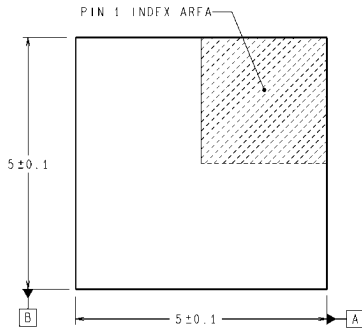

DIMENSIONS ARE IN MILLIMETERS
DIMENSIONS IN () FOR REFERENCE ONLY

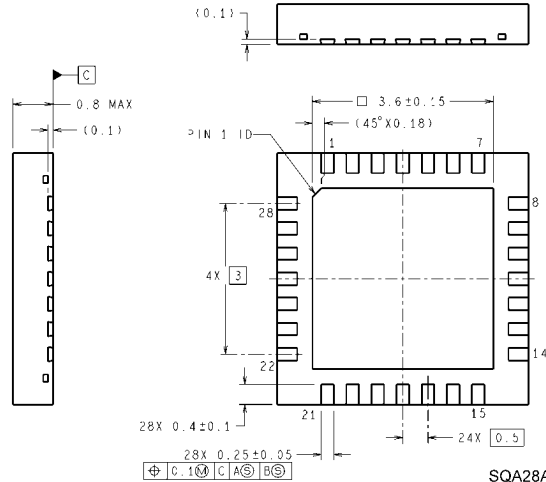

28 Lead LLP
Order Number LM49270SQ
NS Package Number NSQAQ028

SQA28A (Rev B)

Notes

LM49270

Notes

THE CONTENTS OF THIS DOCUMENT ARE PROVIDED IN CONNECTION WITH NATIONAL SEMICONDUCTOR CORPORATION ("NATIONAL") PRODUCTS. NATIONAL MAKES NO REPRESENTATIONS OR WARRANTIES WITH RESPECT TO THE ACCURACY OR COMPLETENESS OF THE CONTENTS OF THIS PUBLICATION AND RESERVES THE RIGHT TO MAKE CHANGES TO SPECIFICATIONS AND PRODUCT DESCRIPTIONS AT ANY TIME WITHOUT NOTICE. NO LICENSE, WHETHER EXPRESS, IMPLIED, ARISING BY ESTOPPEL OR OTHERWISE, TO ANY INTELLECTUAL PROPERTY RIGHTS IS GRANTED BY THIS DOCUMENT.

TESTING AND OTHER QUALITY CONTROLS ARE USED TO THE EXTENT NATIONAL DEEMS NECESSARY TO SUPPORT NATIONAL'S PRODUCT WARRANTY. EXCEPT WHERE MANDATED BY GOVERNMENT REQUIREMENTS, TESTING OF ALL PARAMETERS OF EACH PRODUCT IS NOT NECESSARILY PERFORMED. NATIONAL ASSUMES NO LIABILITY FOR APPLICATIONS ASSISTANCE OR BUYER PRODUCT DESIGN. BUYERS ARE RESPONSIBLE FOR THEIR PRODUCTS AND APPLICATIONS USING NATIONAL COMPONENTS. PRIOR TO USING OR DISTRIBUTING ANY PRODUCTS THAT INCLUDE NATIONAL COMPONENTS, BUYERS SHOULD PROVIDE ADEQUATE DESIGN, TESTING AND OPERATING SAFEGUARDS.

EXCEPT AS PROVIDED IN NATIONAL'S TERMS AND CONDITIONS OF SALE FOR SUCH PRODUCTS, NATIONAL ASSUMES NO LIABILITY WHATSOEVER, AND NATIONAL DISCLAIMS ANY EXPRESS OR IMPLIED WARRANTY RELATING TO THE SALE AND/OR USE OF NATIONAL PRODUCTS INCLUDING LIABILITY OR WARRANTIES RELATING TO FITNESS FOR A PARTICULAR PURPOSE, MERCHANTABILITY, OR INFRINGEMENT OF ANY PATENT, COPYRIGHT OR OTHER INTELLECTUAL PROPERTY RIGHT.

LIFE SUPPORT POLICY

NATIONAL'S PRODUCTS ARE NOT AUTHORIZED FOR USE AS CRITICAL COMPONENTS IN LIFE SUPPORT DEVICES OR SYSTEMS WITHOUT THE EXPRESS PRIOR WRITTEN APPROVAL OF THE CHIEF EXECUTIVE OFFICER AND GENERAL COUNSEL OF NATIONAL SEMICONDUCTOR CORPORATION. As used herein:

Life support devices or systems are devices which (a) are intended for surgical implant into the body, or (b) support or sustain life and whose failure to perform when properly used in accordance with instructions for use provided in the labeling can be reasonably expected to result in a significant injury to the user. A critical component is any component in a life support device or system whose failure to perform can be reasonably expected to cause the failure of the life support device or system or to affect its safety or effectiveness.

National Semiconductor and the National Semiconductor logo are registered trademarks of National Semiconductor Corporation. All other brand or product names may be trademarks or registered trademarks of their respective holders.

Copyright© 2007 National Semiconductor Corporation

For the most current product information visit us at www.national.com



**National Semiconductor
Americas Customer
Support Center**
Email:
new.feedback@nsc.com
Tel: 1-800-272-9959

**National Semiconductor Europe
Customer Support Center**
Fax: +49 (0) 180-530-85-86
Email: europe.support@nsc.com
Deutsch Tel: +49 (0) 69 9508 6208
English Tel: +49 (0) 870 24 0 2171
Français Tel: +33 (0) 1 41 91 8790

**National Semiconductor Asia
Pacific Customer Support Center**
Email: ap.support@nsc.com

**National Semiconductor Japan
Customer Support Center**
Fax: 81-3-5639-7507
Email: jpn.feedback@nsc.com
Tel: 81-3-5639-7560